



flow & process solutions





Potravinářský průmysl
Farmaceutický průmysl
Biotechnologie
Petrochemie
Chemický průmysl
Energetika
Úprava vody
Papírenství a zpracování celulózy
Plynárenský průmysl
Keramický průmysl
Zpracovatelský průmysl



Firma s tradicí od r. 1990 se při svém vzniku zaměřila na dodávky základních komponent, přístrojové a měřicí techniky a dodávky technologií pro farmaceutický a potravinářský průmysl. Cílem bylo zajistit kompletní dodavatelsko - inženýrské služby, včetně servisu. V roce 1998, který byl pro firmu velmi významným mezníkem, proběhla transformace společnosti do nynější formy. V dalších letech činnosti společnosti dochází k rozšíření portfolia a je navazována spolupráce s partnery v oblasti armatur, komponent, ventilů, procesní měřicí techniky a čerpadel.

Oblastí působnosti je potravinářský, farmaceutický průmysl, biotechnologie, chemický průmysl, petrochemie, úprava vody, papírenství a celulóza, energetika, keramický průmysl a zpracovatelský průmysl.

Firma REGOM INSTRUMENTS je díky širokému dodavatelskému portfoliu a bohatým zkušenostem schopna zajistit dodávky armatur, komponent, čerpadel, přístrojů a zařízení.

Cílem společnosti REGOM INSTRUMENTS je poskytování kvalitních služeb a spolehlivých dodávek pro co nejširší okruh zákazníků.

Product Information TFP-59, -68, -179, -199

FOOD

Temperature Sensor for Build-In System G3/8" FLEXadapt



Application/Specified usage

- Temperature measuring in pipes and vessels without opening the process with prefabricated thermowells and build-in systems
- Demounting the sensor without opening the process and without electrical disconnection > avoiding downtime of the equipment at calibration and maintenance!
- Suitable at small pipe diameters with build-in system ESF-G (available for pipes DN25...DN100)

Application examples

- Flexible applicable for nearly every temperature measuring task in pipes and vessels
- Safe temperature measuring in hotsteam- and pressure pipes (enclosed process)
- Monitoring of CIP- / SIP-cleaning

Hygienic design/Process connection

- Hygienic and easy sterilizable installation by using Negele build-in system ESF
- CIP-/SIP-cleaning up to 140 °C
- Product contacting materials are compliant to FDA
- Sensor completely made of stainless steel

Features

- Short reaction time, very compact measure point
- Integrated transmitter (optional)
- Threaded thermowells ESF-G1/2" for CLEANadapt can be combined with many other standard adapters. Therefore they are suitable for each application and process connection (e.g. Tri-Clamp, dairy flange (DIN 11851), DRD, Varivent, APV, BioControl...)
- Quick and easy to install with an orbital welding machine (ESF-G)
- Temperature sensors and build-in systems with pre-defined, concerted standard lengths, reducing the variety and economize costs for storage and simplify the maintenance.
- Different types of electrical connection available
- Protection class IP 69 K (with electrical connection M12 plug)

Options/Accessories

- 2 x Pt100 (not retrofittable)
- 2 x Pt100 with two transmitters (not retrofittable)
- Programmable transmitters MPU-4 and MPU-M with output 4...20 mA, 2-wire
- Integrated transmitter for HART-protocol
- Programming adapter MPU-P 9701
- Integrated transmitter MPU-LCD with display in connecting head
- Pt100-chip with other classes of accuracy, (1/3 B, 1/10 B)
- Pre-assembled connecting cable for M12 plug
- Fixed cable in other lengths and material available

Authorisations



Temperatur sensor TFP-59



Build-in system ESF ESF-G1/2", ESF-EH, ESF-KM



Temperature Sensor		
Process connection	thermowell	G3/8" external thread
Insertion length	standard	37, 83, 97, 160 mm
Materials	connection head protection tube cap nut spacer	stainless steel 1.4301 (AISI 304) stainless steel 1.4404 (AISI 316L) stainless steel 1.4571 (AISI 316Ti) stainless steel 1.4301 (AISI 304), Ø 10 mm
Temperature ranges	ambient sensor tip	-50...+80 °C -50...+250 °C
Sensing resistor	acc. to DIN EN 60751	Pt100
Electrical connection	TFP-59 or TFP-179 TFP-199	cable gland M16 x 1.5 M12 plug 1.4301 (AISI 304), 4-pin M12 plug 1.4301 (AISI 304) fixed cable (PVC), standard: 2.5 m
Protection class		IP 69 K (with electrical connection M12 plug)

Transmitter MPU-4, MPU-H, MPU-M		
Temperature ranges	ambient storage	-40...+85 °C -55...+90 °C
Measuring ranges	MPU-4, MPU-H, MPU-M	standard: -10...40 °C, 0...50 / 100 / 150 / 200 °C special ranges free programmable
Accuracy	input	< ±0.25 °C
Temperature drift	zero, span	< 0.01 % / K
Supply	MPU-4, MPU-H, MPU-M accuracy	8...35 V DC 0.01 % / V (reference: 12 V DC)
Output	signal accuracy burden	analog 4...20 mA < ±0.1 % of measurement range < 600 Ω (at U _B = 24 V)
Humidity	without condensation	0...98 %

Accuracy classes of temperature sensors | Tolerances for Pt100 acc. to DIN EN 60751

Pt100	A	1/3 B	1/10 B
0 °C / 100 Ω	±0.15 K / ±0.06 Ω	±0.10 K / ±0.04 Ω	±0.03 K / ±0.01 Ω
100 °C / 138.5 Ω	±0.35 K / ±0.13 Ω	±0.27 K / ±0.10 Ω	±0.08 K / ±0.03 Ω

Table Reaction Time	ESF-G-DIN2-25	ESF-G1/2"-40	ESF-EH-125	ESF-KM-125
Medium temperature 90 °C				
t ₅₀	5,8 s	7,8 s	8,0 s	8,0 s
t ₉₀	19,0 s	21,1 s	24,0 s	24,0 s

Reaction Time



We recommend the use of heat-conductive paste to reduce the mentioned reaction times down to approx. 50 %!

Electrical connection without transmitter

With 1 x M12 plug

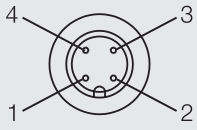

Configuration 1st M12 plug

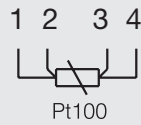

Electrical connection with transmitter

With M12 plug

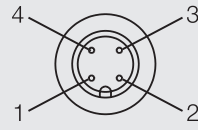

Configuration M12 plug

- 1: + supply
- 2: - supply 4...20 mA
- 3: not connected
- 4: not connected

With 2 x M12 plug

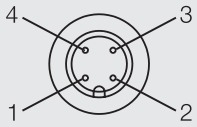

Configuration 2nd M12 plug

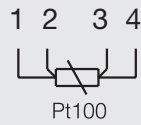

With cable gland

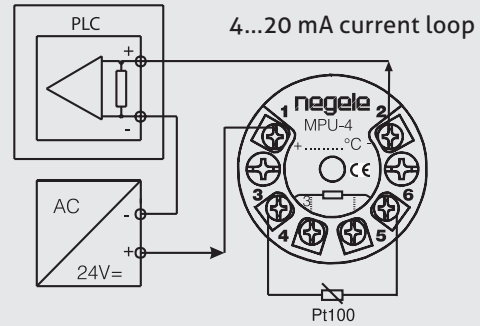

With cable gland

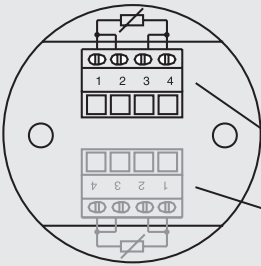

Configuration strip terminal

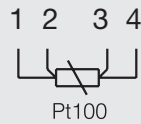

- clamps for 1st Pt100
- clamps for 2nd Pt100 (at version 2 x Pt100)

Electrical connection with two transmitter (TFP-68)

With 1 x M12 plug (sensor 1 + sensor 2)

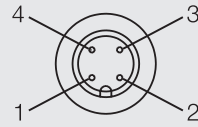

Configuration M12 plug

- 1: + supply (sensor 1)
- 2: - supply 4...20 mA (sensor 1)
- 3: - supply 4...20 mA (sensor 2)
- 4: + supply (sensor 2)

With fixed cable PVC (0...90 °C)



Fixed cable connection with 1 x Pt100

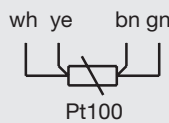

With 2 x M12 plug (sensor 1)

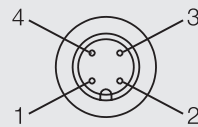

Configuration M12 plug

- 1: + supply (sensor 1)
- 2: - supply 4...20 mA (sensor 1)
- 3: not connected
- 4: not connected

With 2 x M12 plug (sensor 2)

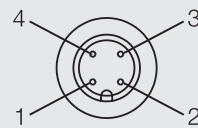

Configuration M12 plug

- 1: + supply (sensor 2)
- 2: - supply 4...20 mA (sensor 2)
- 3: not connected
- 4: not connected

TFP-59 | TFP-59.2

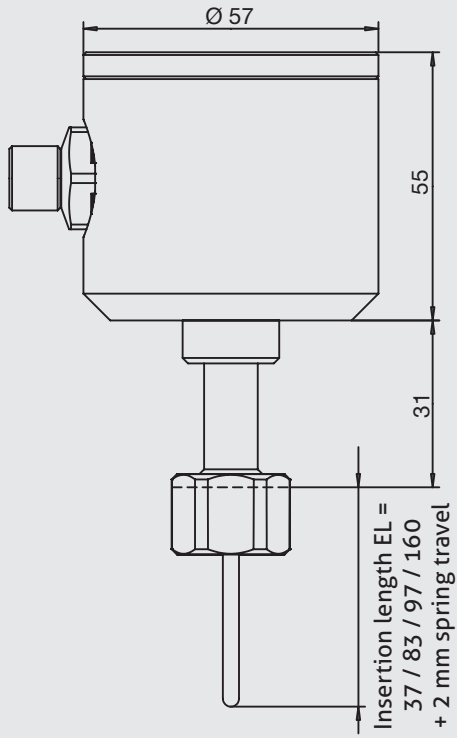

Drawing higher connection head for TFP-68

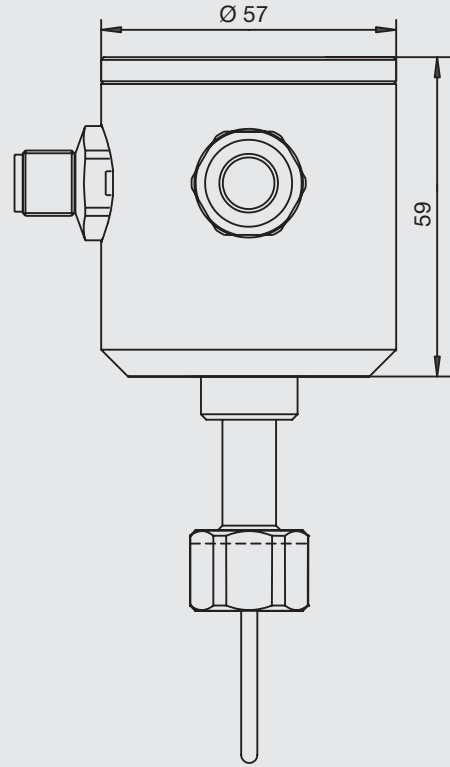

TFP-179 / ...

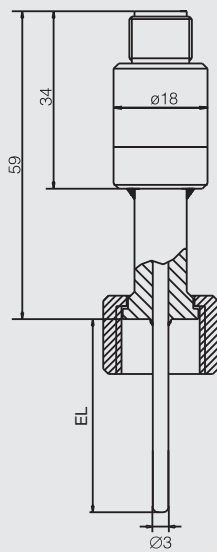

TFP-179 / ... / MPU-M

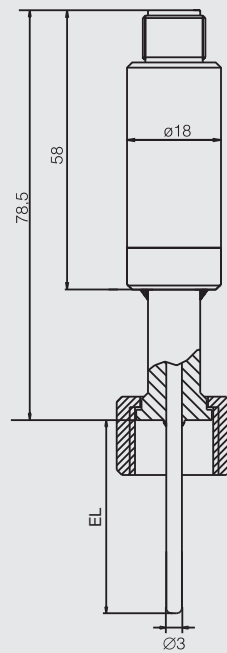

TFP-199 / ...

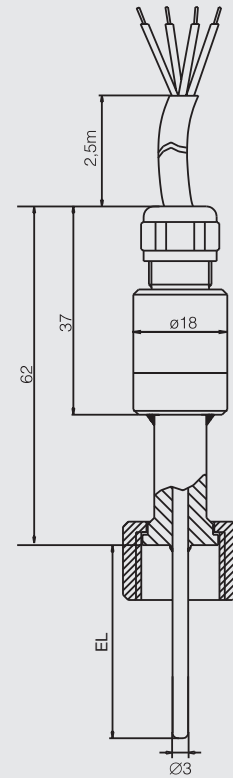

Transport/Storage

- No outdoor storage
- Dry and dust free
- Not exposed to corrosive media
- Protected against solar radiation
- Avoiding mechanical shock and vibration
- Storage temperature -55...+90 °C
- Relative humidity max. 98 %

Reshipment

- Sensors shall be clean and must not be contaminated with dangerous media!
- Use suitable transport packaging only to avoid damage of the equipment!

Standards and guidelines

- Compliance with the applicable regulations and directives is mandatory.

Disposal

- Electrical devices should not be disposed of with household trash. They must be recycled in accordance with national laws and regulations.
- Take the device directly to a specialized recycling company and do not use municipal collection points.

Conventional usage

- Not suitable for applications in explosive areas.
- Not suitable for applications in security-relevant equipments (SIL).

Cleaning/Maintenance

- In case of using pressure washers, don't point nozzle directly to electrical connections!

Mechanical connection/Installation

- To guarantee a definite function use the Negele **FLEXadapt-system ESF!**

Note on CE

- Applicable directives:
Electromagnetic Compatibility Directive 2014/30/EU
- Compliance with the applicable EU directives is identified by the CE label on the product.
- The operating company is responsible for complying with the guidelines applicable to the entire installation.

Temperature Transmitter MPU-LCD with Display

Application/Specified usage

- 4...20 mA transmitter with LCD for Pt100 temperature sensor
- For installation in temperature sensor
- Sensor monitoring

Features

- 4-digit display with green backlight
- Temperature measurement in °C and °F
- Easy range select by one button
- Lower costs for wiring because of 2-wire technology

Note

See product information "MPU-LCD" for details.



Option MPU-LCD (display in the connection head)



Accessories

PVC-cable with M12-connection made of 1.4305, IP 69 K, unshielded
 M12-PVC / 4-5 m PVC-cable 4-pin, length 5 m
 M12-PVC / 4-10 m PVC-cable 4-pin, length 10 m
 M12-PVC / 4-25 m PVC-cable 4-pin, length 25 m

PVC-cable with M12-connection, brass nickel-plated, IP 67, shielded
 M12-PVC / 4G-5 m PVC-cable 4-pin, length 5 m
 M12-PVC / 4G-10 m PVC-cable 4-pin, length 10 m
 M12-PVC / 4G-25 m PVC-cable 4-pin, length 25 m

**Programming adapter
MPU-P 9701**

Programming adapter for
MPU-4, MPU-H and MPU-M

PVC-cable with M12-connection



Programming adapter MPU-P 9701



Order code for version with 1 x Pt100

TFP-59 (connecting head Ø 57 mm, with spring mounted gauge slide)
TFP-179 (connecting head Ø 18 mm, electrical connection via M12 plug)
TFP-199 (connecting head Ø 18 mm, electrical connection via 2.5 m PVC-cable; other lengths: see accessories; no transmitter possible)

Sensor length EL in mm

037 (length 37 mm)
083 (length 83 mm)
097 (length 97 mm, for threaded thermowell ESF-G1/2"-40)
160 (length 160 mm)

Diameter thermowell in mm

3

Diameter sensor tip in mm

3

Accuracy class Pt100

A
1/3B
1/10B

Electrical connection
(not selectable at TFP-179 and -199)

PG (cable gland M16x1.5)
M12 (M12 plug, standard with MPU-LCD)

Transmitter

X (without)

for TFP-59

MPU-4 (programmable)
MPU-H (HART-protocol)
MPU-LCD (with display)

only for TFP-179 (not for TFP-199)

MPU-M (programmable)

Measuring range MPU
(only for types with transmitter;
not for MPU-LCD)

-10...40 (range -10...40 °C)
0...50 (range 0...50 °C)
0...100 (range 0...100 °C)
0...150 (range 0...150 °C)
0...200 (range 0...200 °C)
xx...yy (special range)

TFP-59 / 083 / 3 / 3 / A / M12 / MPU-4 / 0...100 °C

Order code for version with 2 x Pt100

TFP-59.2 (connecting head Ø 57 mm, 2 x Pt100, no transmitter possible!)
TFP-68 (higher connecting head Ø 57 mm, 2 x Pt100, prepared for 2 x transmitter)

Sensor Length in mm

037 (length 37 mm)
083 (length 83 mm)
097 (length 97 mm, for threaded thermowell ESF-G1/2"-40)
160 (length 160 mm)

Diameter thermowell in mm

3

Diameter sensor tip in mm

3

Accuracy class Pt100

A
1/3B
1/10B

Electrical connection (only for TFP-59.2)

PG (cable gland M16x1.5)
2 x PG (2 x cable gland M16x1.5)
2 x M12 (2 x M12 plug)

Electrical connection (only for TFP-68)

M12 (M12 plug)
2 x M12 (2 x M12 plug)

Continue if TFP-68 is selected!
No further options for TFP-59.2!

1. Transmitter

MPU-4 (programmable)

Measuring Range 1. MPU

-10...40 (measuring range -10...40 °C)
0...50 (measuring range 0...+50 °C)
0...100 (measuring range 0...+100 °C)
0...150 (measuring range 0...+150 °C)
0...200 (measuring range 0...+200 °C)
xx...yy (special range)

2. Transmitter

MPU-4 (programmable)

Measuring range 2. MPU

-10...40 (-10...40 °C)
0...50 (0...+50 °C)
0...100 (0...+100 °C)
0...150 (0...+150 °C)
0...200 (0...+200 °C)
xx...yy (special)

TFP-68 / 083 / 3 / 3 / A / M12 / MPU-4 / 0...50 / MPU-4 / 0...50



Copyright© 2008 REGOM INSTRUMENTS s.r.o.

Bez souhlasu REGOM INSTRUMENTS s.r.o. není dovoleno texty či obrazové materiály modifikovat, kopírovat, distribuovat, přenášet, zobrazovat, reprodukovat, publikovat, nebo pomocí nich vytvářet pozměněné materiály.

www.regom.com